

PRODUCT CATALOGUE

Plastic Fasteners & Buckles

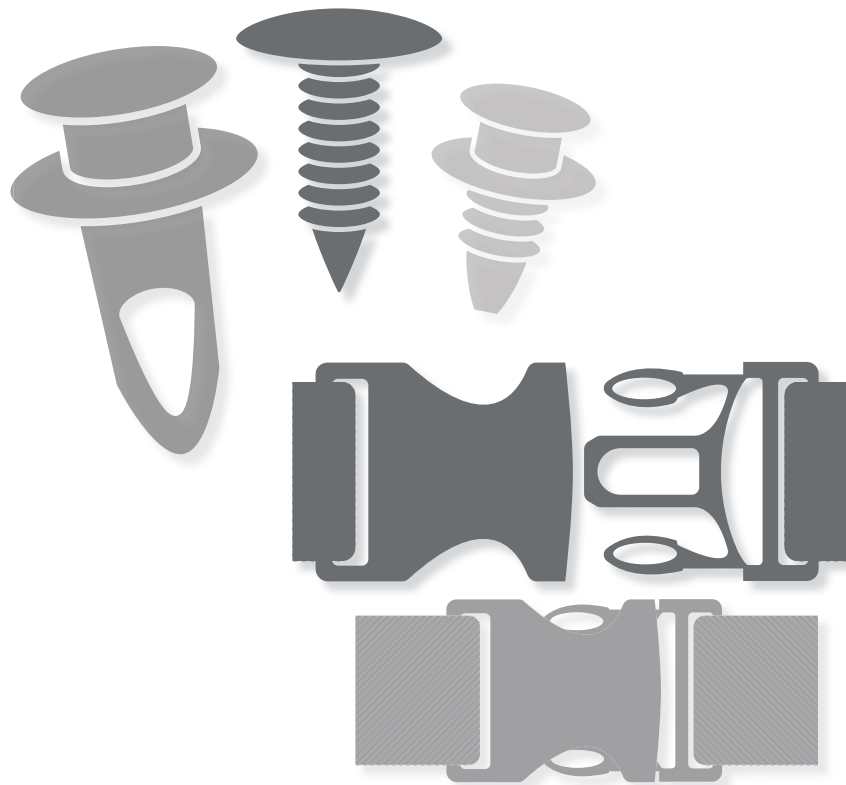

CONTENTS

Plastic Fasteners

PLASTIC RIVETS	Pg 5
RATCHET RIVETS	Pg 6
REMOVABLE RATCHET RIVETS	Pg 7
SCRIVETS	Pg 7
HOLE PLUGS	Pg 8
GROMMETS	Pg 8
SPACER GROMMETS	Pg 9
ANCHOR BUSHES	Pg 9
CANOE CLIPS	Pg 10
CANOE CLIPS (Cont.)	Pg 11
CHRISTMAS TREE CLIPS	Pg 12
CHRISTMAS TREE CLIPS (Cont.)	Pg 13
HANDLE CATCH	Pg 14
DROP WIRE INSULATOR	Pg 14
FLYSCREENS PLUNGER PINS	Pg 14
PCB MOUNT	Pg 15
CABLE STRAPS	Pg 15
LOUVRE LOCKING PIN & PLATE	Pg 16
UNICORN CLIP	Pg 16
TONNEAU FITTINGS	Pg 16
AUTOMOTIVE	Pg 17

Security Seals

METER SEAL	Pg 19
-------------------	-------

CONTENTS

Plastic Buckles

TROVATO SIDE RELEASE	Pg 21
TROVATO SIDE RELEASE (Cont.)	Pg 22
CLASSIC SIDE RELEASE	Pg 23
CAMLOC	Pg 23
TROVATO DOUBLE BAR LADDERLOC	Pg 24
SUPER LADDERLOC	Pg 24
CARABINA SHOCK CORD HOOKS	Pg 24
LOOPLOCS	Pg 25
SPECIALTY BUCKLES - WHISTLE	Pg 25
SPECIALTY BUCKLES - LIFE JACKET	Pg 25
CORD LOCK	Pg 26
TUCK BUCKLE	Pg 26
TRI GLIDE	Pg 26
LADDERLOC	Pg 27
BARRELOC	Pg 27
ICICLE CLIP	Pg 27

CONTACT US

NATIONAL SALES & CUSTOMER SERVICE

Phone: +61 3 9706 5355

Fax: +61 3 9794 0364

Email: customerservicegardenaneta@husqvarnagroup.com

PLASTIC FASTENERS

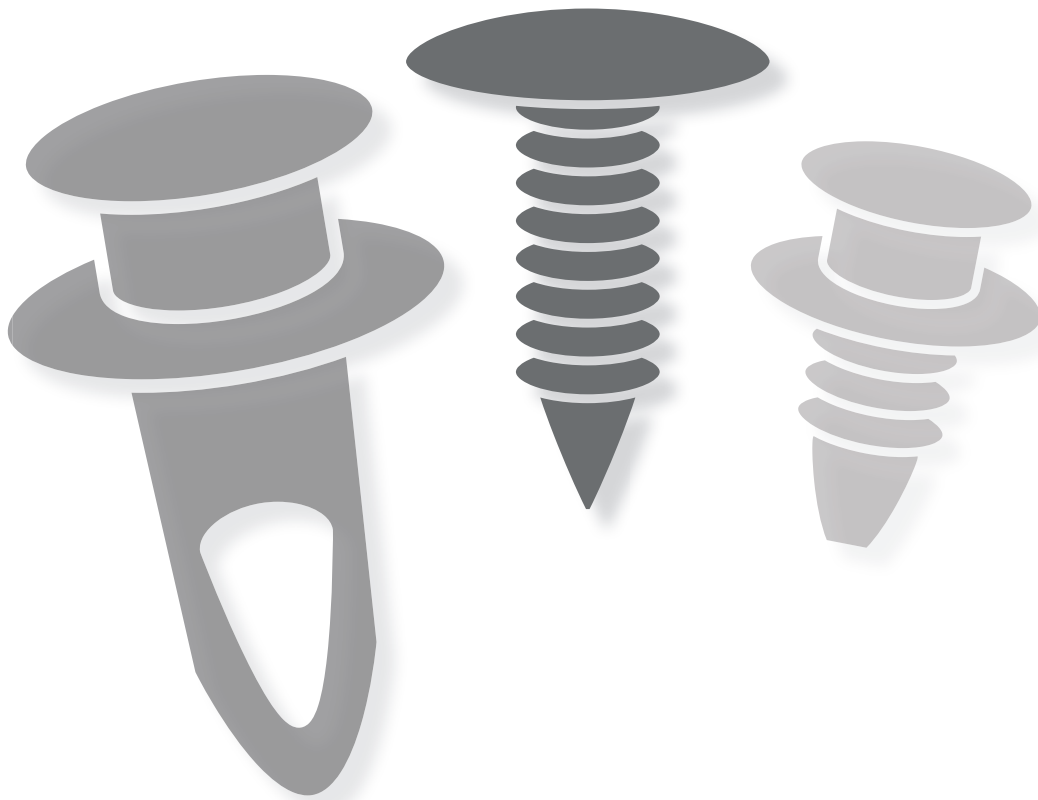

PLASTIC RIVETS

Designed to permanently lock two or more panels together, Plastic Rivets are available in a range of sizes to cater for most fastening applications. If removal becomes necessary, the pin may be driven through the rivet after which the grommet can be prised out. A replacement fastener is then required for re-assembly.

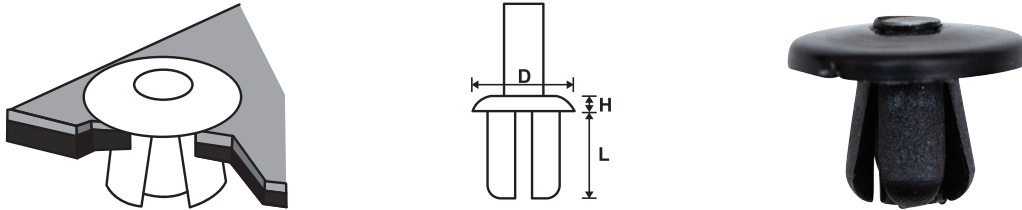

PART ID	ARTICLE NUMBER	COLOUR	HOLE SIZE MM	PANEL THICKNESS	D	H	L	CARTON QTY
967799501	016-0007	Natural	4.8 - 5.4	1.6 - 4.8	11.2	1.8	7.4	7000
967799601	016-0023	White						
967799801	016-0033	Black						
970479001	016-0031	White	4.8 - 5.4	4.6 - 7.4	11.2	2.0	10	5000
970463601	016-0051	Black	4.8 - 5.4	4.6 - 7.4	11.2	2.0	10	10000
967799901	016-0052	Black	5.0 - 5.1	1.0 - 1.5	9.5	1.5	5.0	10000

RATCHET RIVETS

Two identical parts ratchet together to provide a permanent assembly of two or more thicknesses of material, and a neat, finished appearance on both sides, ideal for rigid or compressible materials. They are available in a range of head and foot sizes and require access to both sides of the job for assembly.

Available Colours: white, black, opaque, and clear.

Available Sizes: small, medium, and large.

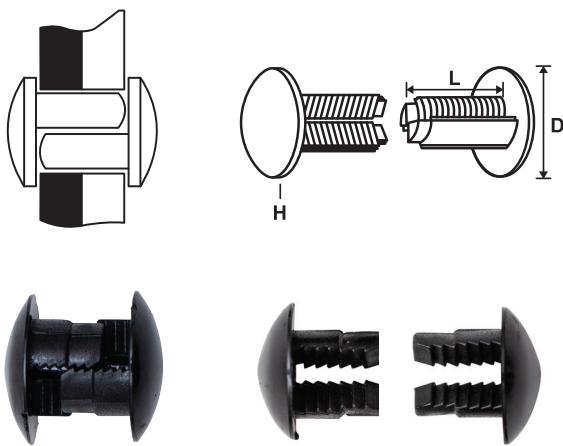

PART ID	ARTICLE NUMBER	COLOUR	HOLE SIZE MM	APPROX GRIP RANGE	D	H	L	CARTON QTY
967799701	016-0025	White	6.7 - 6.9	6.0 - 8.7	10.3	2.6	6.0	13000
967975901	016-0037	Black						
967800001	016-0147	Clear						
970479101	016-0097	White	6.7 - 6.9	10.2 - 15.0	11.5	1.5	10.0	8000
970478901	016-0144	Black						
970492501	016-0148	Opaque						
970478701	016-0111	Black	7.1 - 7.2	15.4 - 21.0	11.5	1.5	15.0	5000
970478801	016-0115	White						
970492601	016-0149	Opaque						

REMOVABLE RATCHET RIVETS

For similar applications to those where Ratchet Rivets may be used but where a removable fastener is required. This two part fastener is pressed together to close, and removed by unscrewing the nut from the shank.

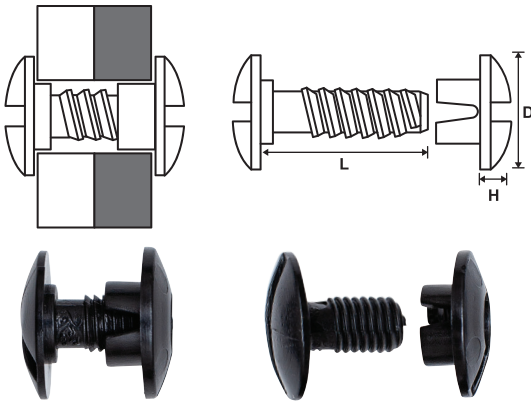

PART ID	ARTICLE NUMBER	COLOUR	HOLE SIZE MM	APPROX GRIP RANGE	D	H	L	CARTON QTY
970479201	010-0090	Natural	6.9 - 7.1	5.5 - 10.5	12.0	2.7	10.8	5000
970479301	010-0104	Black						

SCRIVETS

A removable fastener similar to Plastic Rivets in appearance. They are available in a range of sizes to cater for varying applications and are widely used in the automotive industry.

When removal is necessary the threaded pin can be unscrewed with a Phillips #1 screw driver.

Note: All dimensions detailed below are in mm.

Note: Although a range is given for both the "Hole Size" & "Panel Thickness", there is a specific panel thickness for each 0.1mm of hole size specified within this range.

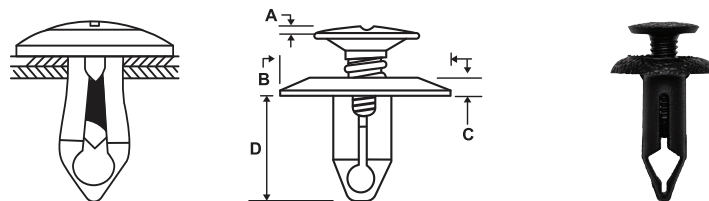

PART ID	ARTICLE NUMBER	COLOUR	HOLE SIZE MM	APPROX GRIP RANGE	D	H	L	CARTON QTY
967800101	020-0015	Black	8.2 - 10.0	2.0 - 6.0	22.2	2.5	9.0	2000
967800201	020-0034	Black	5.9 - 6.1	4.5 - 5.4	15.0	2.3	17.0	10000

HOLE PLUGS

These fittings are designed to attractively cover unwanted holes in panels and are easily applied by hand. Note: All dimensions detailed below are in mm.

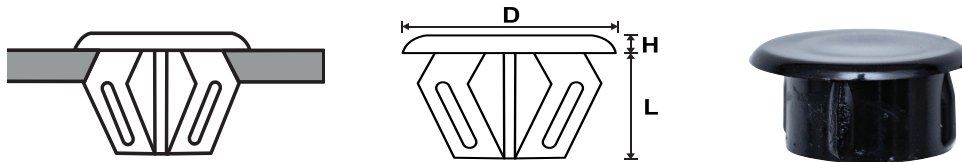

PART ID	ARTICLE NUMBER	COLOUR	HOLE SIZE MM	APPROX GRIP RANGE	D	H	L	CARTON QTY
967814201	036-0003	Natural	8.5 - 9.5	1.2 - 1.6	13.0	1.5	10.1	15000
967814301	036-0077	Black						
967800301	036-0029	Black	10.2 - 10.3	6.4 - INF	12.7	1.1	6.4	15000

GROMMETS

A one piece, snap in, self-retaining blind screw receptacle, which spreads load and insulates at the fastening points. Easy to use and eliminates cross threading. Note: All dimensions detailed below are in mm.

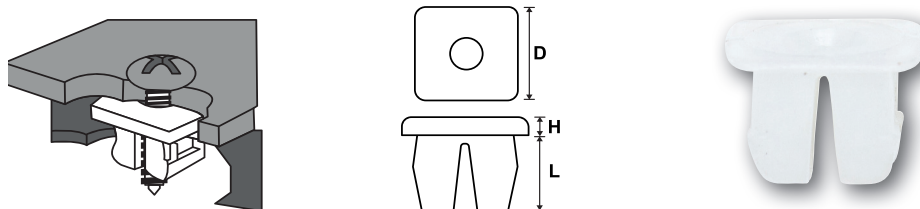

PART ID	ARTICLE NUMBER	COLOUR	HOLE SIZE MM	SCREW SIZE	APPROX GRIP RANGE	D	H	L	CARTON QTY
967800401	046-0001	Natural	9.4 - 9.6	10.0	0.8 - 2.7	17.0	1.9	6.8	3000
967800501	046-0002	Natural	9.4 - 9.6	14.0	0.8 - 2.7	17.3	1.9	6.8	8000
967800601	046-0007	Natural	6.7 - 7.1	8.0	0.8 - 3.9	9.5	0.8	8.1	5000
967800901	046-0010	Natural	6.9 - 7.3	8 or 10	0.8 - 3.9	10.4	0.8	8.1	4000
967801001	046-0012	Natural	6.9 - 7.3	8 or 10	0.8 - 3.9	12.7	3.3	8.1	4000
967801101	046-0013	Natural	8.3 - 8.7	14.0	0.8 - 3.9	14.2	1.6	8.1	10000
967801201	046-0026	Natural	9.0 - 9.2	M5	0.8 - 2.0	14.1	2.0	6.8	10000
967801301	046-0030	Natural	8.5 - 8.7	M5	0.9 - 1.5	12.0	2.0	8.0	4000

SPACER GROMMETS

These perform identically to the standard Grommets, but this range is designed for specific applications which may require greater clearance between panels, or angled screw entry for example. Note: All dimensions detailed below are in mm.

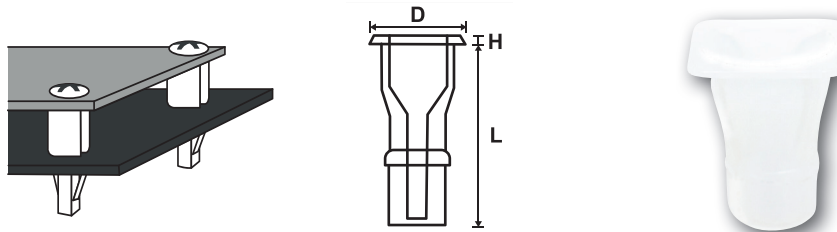

PART ID	ARTICLE NUMBER	COLOUR	HOLE SIZE MM	SCREW SIZE	APPROX GRIP RANGE	D	H	L	CARTON QTY
967801401	056-0004	Natural	6.8 - 7.1	8 Gauge	0.3 - 1.1	9.5	0.7	15.0	6000

ANCHOR BUSHES

Bushes are designed to be used where metal rods pass through panels. Fitted into the panel the bush provides insulation to the rod preventing rattles and squeaks. Nylon bushes will also act as a bearing where a moderate load is applied. Note: All dimensions detailed below are in mm.

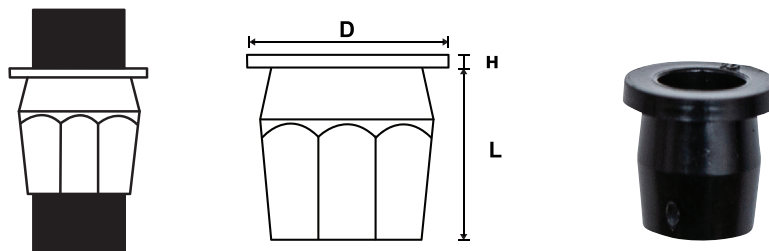

PART ID	ARTICLE NUMBER	COLOUR	HOLE SIZE MM	STUD SIZE	APPROX GRIP RANGE	D	H	L	CARTON QTY
967801801	086-0003	Natural	6.3 - 6.4	4.7	1.3 - 2.3	8.6	1.1	6.0	12000
967801901	086-0004	Black							
967802001	086-0036	Black	7.1 - 7.2	5.4	0.9 - 3.3	9.0	1.0	6.3	10000

CANOE CLIPS

A simple replacement for screws and rivets. The clips snap into round holes securely holding in metal, plastic and a variety of materials. Canoe Clips are ideal for lightweight panel fastening and similar applications.

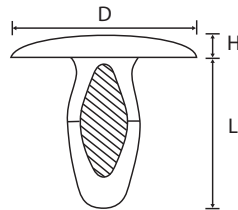
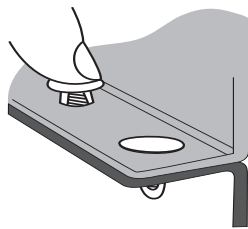

PART ID	ARTICLE NUMBER	COLOUR	HOLE SIZE MM	APPROX GRIP RANGE	D	H	L	CARTON QTY
967802101	096-0001	Natural	3.3 - 3.6	1.5 - 2.3	10.3	3.8	6.9	13000
967802201	096-0025	Black						
967802301	096-0002	Natural	3.3 - 3.6	0.9 - 1.9	10.3	2.4	9.3	5000
970479401	096-0005	Black						15000
967802801	096-0185	White						15000
967803001	096-0003	Natural	3.3 - 3.6	1.5 - 4.0	7.9	2.5	11.1	20000
967803101	096-0125	Black						
967863901	096-0071	Natural	3.3 - 3.6	1.5 - 4.0	7.6	1.5	11.1	6000
967804501	096-0099	Black						
967803301	096-0015	Natural	3.3 - 3.6	2.4 - 5.0	7.6	1.3	12.9	15000
967804301	096-0172	Black						
967804401	096-0177	Natural	4.3 - 4.4	1.5 - 1.9	8.9	5.0	7.6	10000
967802701	096-0008	Natural	4.6 - 4.8	2.5 - 2.6	9.5	1.5	11.1	10000
967803901	096-0084	Black						
970479501	096-0014	White						
967803501	096-0022	Black	4.6 - 4.8	2.3 - 5.0	9.6	1.5	13.4	10000
970463701	096-0198	White						

CANOE CLIPS (Cont.)

PART ID	ARTICLE NUMBER	COLOUR	HOLE SIZE MM	APPROX GRIP RANGE	D	H	L	CARTON QTY
967803401	096-0020	Natural	5.4 - 6.1	2.0 - 4.0	9.5	1.1	11.5	10000
967804601	096-0197	Black						
967804201	096-0023	Black	5.5 - 5.7	3.0 - 11.0	14.2	2.2	15.2	5000
967803201	096-0010	Natural	6.2 - 6.5	2.3 - 5.0	12.7	1.3	16.0	15000
967803701	096-0013	Black						
970455401	096-0011	Natural	6.9 - 7.1	2.5 - 5.5	14.5	2.0	17.0	8000
967804101	096-0049	Black						
967804701	096-0268	White	7.7 - 8.0	3.1 - 6.3	14.2	2.0	17.0	9000
967803801	096-0076	Black	8.2 - 8.4	3.0 - 4.0	14.5	2.0	16.0	9000

CHRISTMAS TREE CLIPS

An extremely versatile fastener designed to hold two or more panels together, particularly where the final panel has a blind hole. Christmas Tree Clips are available in a large range of colours, head styles, sizes, and foot lengths to suit most applications.

Standard Colours: a range of common colours are permanently available.

Custom Colours: 50+ custom colours are available - made to order, upon request.



PART ID	ARTICLE NUMBER	COLOUR	HEAD STYLE	HOLE SIZE MM	APPROX GRIP RANGE	D	H	L	CARTON QTY
967806101	266-0001	Black	Domed	6.6 - 7.5	2.5 - 19.5	16.0	2.0	27.0	5000
967807901	266-0481	Beige							
967810201	266-0550	Slate Grey							
970479601	266-0805	Pale Grey							
967808401	266-0822	Bus Grey							
967806201	266-0006	Black	Flat	6.6 - 7.5	2.5 - 19.5	16.0	1.2	27.0	5000
967959001	266-0829	White							
967806301	266-0007	Black	Flat	6.6 - 7.5	2.5 - 19.5	20.5	1.2	27.0	4000
967807301	266-0156	White							
967807601	266-0019	Black	Flat	6.0 - 6.8	2.6 - 28.0	12.0	1.0	36.0	7500
967807701	266-0022	White							
967810101	266-0501	Mist Grey							
967810301	266-0601	Beige							
967810501	266-0701	White Smoke							
967806401	266-0021	Black	Domed	7.8 - 8.1	2.4 - 10.0	18.0	2.0	19.6	6000

CHRISTMAS TREE CLIPS (Cont.)

PART ID	ARTICLE NUMBER	COLOUR	HEAD STLYE	HOLE SIZE MM	APPROX GRIP RANGE	D	H	L	CARTON QTY
967806501	266-0026	Black	Domed	6.0 - 6.8	2.5 - 10.8	14.0	2.0	15.0	10000
967808301	266-0718	White							
967806901	266-0062	Black	Domed	4.8 - 5.1	2.0 - 9.0	12.0	1.5	15.0	5000
967806601	266-0050	White							
970479701	266-0663	Beige							
970479801	266-0664	Pale Grey							
967972001	266-0562	Metal Grey							
967806701	266-0052	Black	Domed	7.8 - 8.1	2.4 - 8.5	18.5	2.0	13.0	6000
967806801	266-0053	Black	Domed	6.8 - 7.2	2.0 - 10.0	17.0	3.0	17.5	5000
967807001	266-0115	Black	Flat	6.0 - 6.8	2.5 - 10.0	20.2	1.7	15.0	6000
967807101	266-0152	Black	Domed	6.6 - 7.5	2.5 - 7.5	14.0	2.0	10.5	12000
967807201	266-0153	Classic Cream							
967807401	266-0185	Black	Domed	4.9 - 5.1	2.0 - 10.0	15.0	2.0	15.0	5000
967807501	266-0212	Black	Domed	7.8 - 8.1	2.0 - 13.0	18.0	2.0	24.5	5000
970492401	266-0222	Metal Grey							
967807801	266-0333	Black	Domed	5.9 - 6.1	2.0 - 10.0	16.0	2.0	15.0	3000
970479901	266-0811	Clear							
967810401	266-0658	Black	Flat	6.4 - 6.6	2.5 - 30.0	34.8	3.2	36.0	1000
967808201	266-0714	Slate Grey							

HANDLE CATCH

A one piece moulded handle designed for use in laundry troughs, cabinet doors, or other doors in light gauge metal cabinets. Note: All dimensions detailed below are in mm.

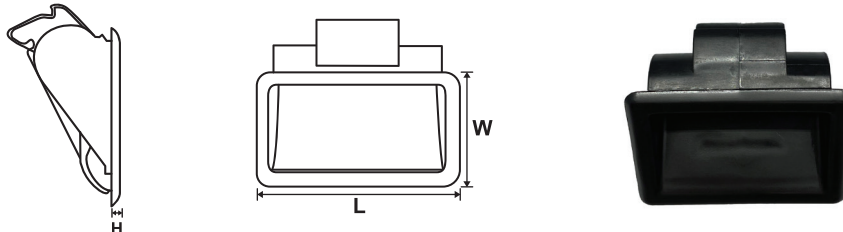

PART ID	ARTICLE NUMBER	COLOUR	DESCRIPTON	HOLE SIZE MM	L	W	H	CARTON QTY
967808701	296-0001	Black	Handle Catch	0.9	65.0	44.5	2.8	350

DROP WIRE INSULATOR

For use with drop wire insulator clamps - Telstra Approved.



PART ID	ARTICLE NUMBER	COLOUR	DESCRIPTON	CARTON QTY
967805901	166-0039	Black	Drop Wire Insulator	1200

FLYSCREEN PLUNGER PINS

A one piece fastener for attaching aluminium flyscreens to window frames. The pin is easily withdrawn into the flyscreen frame to permit removal from the window when required.

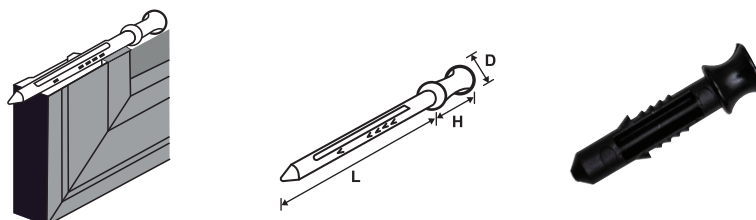

PART ID	ARTICLE NUMBER	COLOUR	PANEL THICKNESS	HOLE SIZE MM	D	H	L	CARTON QTY
967809401	356-0026	Black	STD 24mm Frame	4.8	7.0	10.0	33.0	8000

PCB MOUNT

Designed to hold printed circuit boards securely in position and insulate them from the surrounding chassis, this fastener snaps into prepared holes for ease of use.

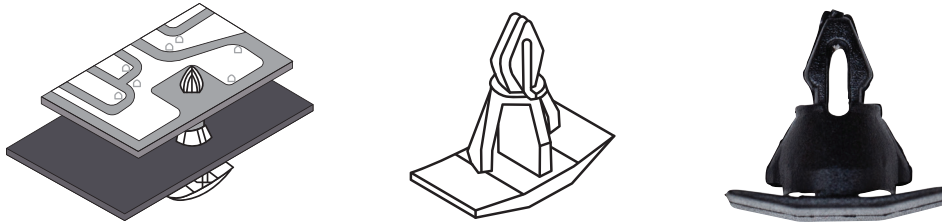

PART ID	ARTICLE NUMBER	COLOUR	PANEL CLEAR-ANCE	PC BOARD PANEL THICKNESS	PC BOARD PANEL HOLE SIZE MM	CHASSIS PANEL THICKNESS	CHASSIS HOLE SIZE MM	CARTON QTY
967805801	166-0013	Black	6.5	1.4 - 1.6	3.4 - 3.6	0.9 - 1.1	7.8 - 8.0	15000

CABLE STRAPS

Designed to hold bundles of wires to chassis, these straps provide for easy control of quite large bundles of wires. They may be opened and closed again for the addition or removal of wires.



PART ID	ARTICLE NUMBER	COLOUR	HOLE SIZE	PANEL THICKNESS	CABLE CAPACITY	W	L	CARTON QTY
967804801	116-0001	Black	6.5	0.5 - 1.0	14 MAX	7.5	73.0	6000
967804901	116-0095	Black	6.7	1.0 - 1.2	34 MAX	6.6	148.0	2000

LOUVRE LOCKING PIN & PLATE

Car window louvre fastening plates and locking pins.

PART ID	ARTICLE NUMBER	COLOUR	DESCRIPTON	CARTON QTY
967813901	136-0005	Black	Louvre Locking Pin	6000
967812001	476-0277	Black	Louvre Plate	3000



UNICORN CLIP

PART ID	ARTICLE NUMBER	COLOUR	CARTON QTY
967812301	616-0002	Black	2000



TONNEAU FITTINGS







Genuine OEM automotive components used to attach tonneau covers, such as those commonly used on utilities to the vehicle body.



PART ID	ARTICLE NUMBER	COLOUR	DESCRIPTON	HOLE SIZE MM	L	W	H	CARTON QTY
967809001	346-0005	Black	Tonneau Hook (GMH)	6.4	38.0	29.0	13.5	1500
967809201	346-0021	Black	Rope Button	4.2	-	20.0	15.0	2000
967809301	356-0002	Black	Pin (GMH)	To Be Used with 346-005				4500

AUTOMOTIVE

Automotive fasteners designed to secure a wide range of panels and fittings. Please note photos are not to scale and therefore should not be used as a guide to relative size. All data presented is given as a service and guide only.

PART ID	ARTICLE NUMBER	COLOUR	DESCRIPTON	IMAGE	CARTON QTY
967805101	146-0022	Natural Hose Size 7.8 - 8.1	Door Trim Panel Thickness 1.2 - 2.2		5000
967971101	146-0094	Black	Trim Clip		5000
967805201	146-0151	Natural	Moulding Clip		2500
967805301	146-0156	Black	Bumper Skin		6000
967805601	146-0320	Natural Hole Size 4.7	Weather Seal Clip Panel Thickness 1.2		30000
967805701	146-0469	Natural	Weather Seal Clip		10000

SECURITY SEALS



METER SEAL

The meter seal although originally designed for use with Electricity Meters, is a simple one piece seal that can be used for a variety of applications.

Requires a crimping tool for sealing.

Will fit into holes down to 1.5mm.

U.V. Stabilised to provide increase durability.

Available in a range of colours (subject to minimum orders).

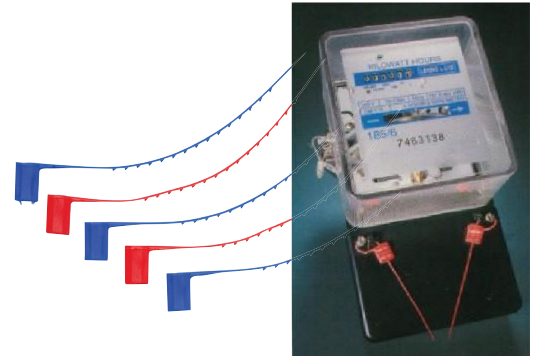

PART ID	ARTICLE NUMBER	COLOUR	DESCRIPTON	TYPE	LENGTH	CARTON QTY
967812101	486-0211	Red	Meter Seal	Crimp	120mm	5000
967812201	486-0214	Blue	Meter Seal	Crimp	120mm	5000

PLASTIC BUCKLES

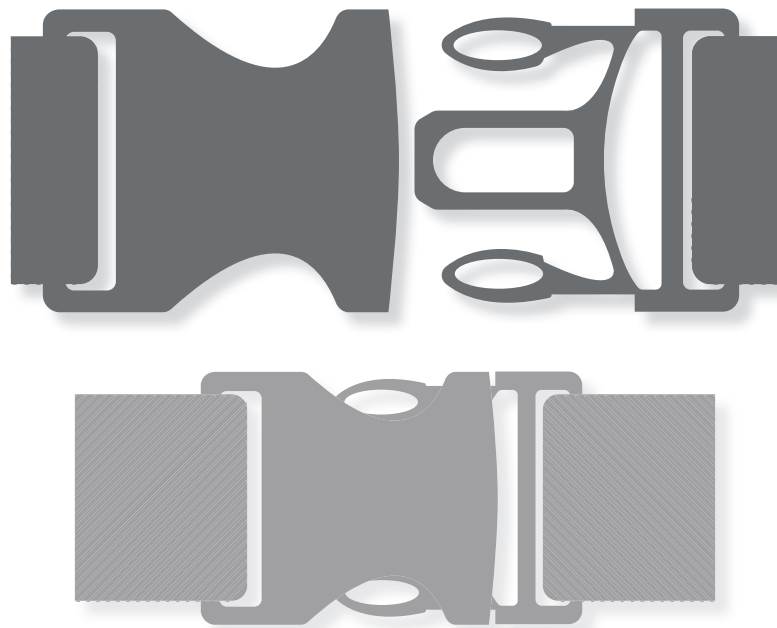

TROVATO SIDE RELEASE

The “Trovato” range is our premium range side release buckles that have been engineered to provide maximum strength and performance. Complimenting this is the stylish design and high quality surface finish making the “Trovato” series both extremely pleasing to the eye as well as ideal for side release applications.



PART ID	ARTICLE NUMBER	WEBBING SIZE	MATERIAL	COLOUR	DESCRIPTION	TYPE	CARTON QTY
967813101	950-1142	20mm / ¾”	Acetal	Black	Trovato	SR Single	2000
967813001	950-1135	25mm / 1”	Acetal	Black	Trovato	SR Single	1000
967812801	950-1115	40mm / 1½”	Acetal	Black	Trovato	SR Single	500
967812601	950-1113	50mm / 2”	Acetal	Black	Trovato	SR Single	350



PART ID	ARTICLE NUMBER	WEBBING SIZE	MATERIAL	COLOUR	DESCRIPTION	TYPE	CARTON QTY
967812401	950-1099	50mm / 2”	Acetal	Black	Trovato	DLL Dual	350

PART ID	ARTICLE NUMBER	WEBBING SIZE	MATERIAL	COLOUR	DESCRIPTION	TYPE	CARTON QTY
967813401	956-0761	25mm	Acetal	Khaki	Trovato	Superloc	3000

These buckles are also available in Nylon but Minimum Order Quantities may apply.

TROVATO SIDE RELEASE (Cont.)

The “Trovato” range is our premium range side release buckles that have been engineered to provide maximum strength and performance. Complimenting this is the stylish design and high quality surface finish making the “Trovato” series both extremely pleasing to the eye as well as ideal for side release applications.



PART ID	ARTICLE NUMBER	WEBBING SIZE	MATERIAL	COLOUR	DESCRIPTION	TYPE	CARTON QTY
967812701	950-1114	25mm/1”	Nylon	Black	Trovato	SR Single	350
967812901	950-1117	40mm/1½”	Nylon	Black	Trovato	SR Single	500



PART ID	ARTICLE NUMBER	WEBBING SIZE	MATERIAL	COLOUR	DESCRIPTION	TYPE	CARTON QTY
967812501	950-1102	50mm	Nylon	Black	Trovato	SR DLL	350
967813201	950-1156	25mm	Nylon	Black	Trovato	SR DLL	1000

CLASSIC SIDE RELEASE

The “Classic” style of side release buckle has stood the test of time. Meticulously engineered to provide superior strength the “Classic” style buckle is still the preferred shape used by the Australian Defence Force and a number of semi-military or government style organisations.



PART ID	ARTICLE NUMBER	WEBBING SIZE	MATERIAL	COLOUR	DESCRIPTION	TYPE	CARTON QTY
967810601	380-0004	25mm / 1"	Acetal	Black	Classic	SR Single	1000
967810701	380-0044	50mm / 2"	Acetal	Black	Classic	SR Single	400

These buckles are also available in Nylon but Minimum Order Quantities may apply.

CAMLOC

Camloc Buckles provide an easy-to-use and easy-to-adjust means of securing webbing. The locking doors trap the webbing to prevent unintentional slippage. The “robust” design and glass filled nylon material used for manufacture of the 50mm Camloc buckle, ensures maximum performance when securing webbing.



PART ID	ARTICLE NUMBER	WEBBING SIZE	MATERIAL	COLOUR	DESCRIPTION	TYPE	CARTON QTY
967851201	380-1086	50mm/ 2"	Nylon	Black	Camloc	High Performance	250

TROVATO DOUBLE BAR LADDERLOC

This Ladderloc is designed with an optimum release angle to maximize webbing grip while maintaining easy tightening and gradual release. The unique finger access crown eases release while the part hugs the webbing.



PART ID	ARTICLE NUMBER	WEBBING SIZE	MATERIAL	COLOUR	CARTON QTY
967811001	386-0063	25mm	Acetal	Black	5000

SUPER LADDERLOC

Ladderloc adjustment buckles are the most versatile buckles, allowing easy, one-handed release or tightening of webbing and straps. All Ladderlocs have been designed to minimise slippage of the webbing while allowing smooth and easy tightening.



PART ID	ARTICLE NUMBER	WEBBING SIZE	MATERIAL	COLOUR	A	CARTON QTY
967813501	956-1109	25mm / 1"	Acetal	Black	19.1	1500

CARABINA SHOCK CORD HOOKS

The moulded Carabina or Shock Cord Hook & Bush is rust and corrosion proof and being a totally moulded unit, the traditional metal crimp ring is eliminated. The fastening method securely grips shock cord whilst the slip ring conceals the end of the shock cord providing a neat finish.



PART ID	ARTICLE NUMBER	SIZE	MATERIAL	COLOUR	CARTON QTY
967811601	386-0371	8mm	Nylon	Black	1000

LOOPLOCS

Looplocs are ideal for holding straps or webbing where no adjustment is needed. Some versions are made of sewable plastic to simplify manufacturing.



PART ID	ARTICLE NUMBER	WEBBING SIZE	MATERIAL	COLOUR	CARTON QTY
967811301	386-0307	50mm	Acetal	Black	2000

SPECIALTY BUCKLES

The non-corrosive whistle provides an excellent safety device for a variety of outdoor activities. The high pitch sound is significantly louder than a conventional ball whistle and can be heard over long distances. These attributes have allowed to obtain EN394 Approval for this product.



The LJ25 buckle has been developed to provide superior locking strength with anti-pinching characteristics, making this part an excellent choice for safety vests.



PART ID	ARTICLE NUMBER	WEBBING SIZE	MATERIAL	COLOUR	DESCRIPTION	TYPE	CARTON QTY
967811801	386-1170		Acetal	Orange	Whistle		1800
967811701	386-1169		Acetal	Black	Whistle		1800
967313301	950-1195	25mm / 1"	Acetal	Black	Heavy Duty	Life Jacket	500

CORD LOCK

The Cord Lock has been designed to lock the cord only in one direction, allowing the user an easy way to operate. They are suitable for uses involving exposure to the elements and temperature extremes.

Applications include apparel, sporting goods, and industrial uses.



PART ID	ARTICLE NUMBER	LOGO	MATERIAL	COLOUR	DESCRIPTION	CARTON QTY
967809701	386-1231	DDC	Acetal	GREY	BODY	1000
967809601	386-1230	DDC	Acetal	Natural	Wheel	3000

TUCK BUCKLE

Manufactured from a special toughened grade of Khaki coloured Nylon, the buckles are designed to provide maximum performance for applications where functionality is critical.



PART ID	ARTICLE NUMBER	WEBBING SIZE	MATERIAL	COLOUR	DESCRIPTION	TYPE	CARTON QTY
967810901	380-0816	25mm / 1"	Nylon	Khaki	Classic	SR	1000
967975801	380-0928	50mm / 2"	Nylon	Khaki	Classic	SR	400

TRI GLIDE

The Tri-Glide strap adjuster provides length adjustment on strap assemblies. The Tri-Glides grip webbing securely and work well in combination with other buckles as a means of securing loose webbing.



PART ID	ARTICLE NUMBER	WEBBING SIZE	MATERIAL	COLOUR	DESCRIPTION	CARTON QTY
967811201	386-0289	25mm / 1"	Nylon	Khaki	Tri-Glide	3500

LADDERLOC

Ladderloc adjustment buckles are the most versatile buckles, allowing easy, one-handed release or tightening of webbing and straps. All Ladderlocs have been designed to minimise slippage of the webbing while allowing smooth and easy tightening.



PART ID	ARTICLE NUMBER	WEBBING SIZE	MATERIAL	COLOUR	DESCRIPTION	TYPE	CARTON QTY
967811101	386-0064	25mm - 1"	Acetal	Khaki	Super	Ladderloc	5000

BARRELOC

Fits a Variety of Drawstrings allowing for One-Hand Adjustment. Suitable for a variety of cords in a large variety of sizes.



PART ID	ARTICLE NUMBER	WEBBING SIZE	MATERIAL	COLOUR	DESCRIPTION	TYPE	CARTON QTY
967810801	380-0141		Acetal	Khaki	Barreloc	Large	3500

ICICLE CLIP

High-performance military clip used to fasten webbing and other special attachments to soldiers uniform.



PART ID	ARTICLE NUMBER	WEBBING SIZE	MATERIAL	COLOUR	DESCRIPTION	TYPE	CARTON QTY
967809501	386-1158	58mm	Nylon	Khaki	Icicle Clip		1500



NATIONAL SALES & CUSTOMER SERVICE

Phone: +61 3 9706 5355

Fax: +61 3 9794 0364

Email: customerservicegardenaneta@husqvarnagroup.com

Husqvarna Australia Pty Ltd (ABN 445 115 475 619) reserves the right to correct errors or misprints. E&OE. Any information quoted in this catalogue should be considered approximate only. Images in this catalogue are for illustration purposes only.

Copyright © 2020 GMP. All rights reserved.

Issued:12052020